

3.8
kWh

AmpliPHI 3.8-M™ Battery



The **AmpliPHI™ 3.8** Battery utilizes advanced Lithium Ferro Phosphate (LFP) chemistry that eliminates cobalt which reduces the risk of thermal runaway, fire propagation, operating temperature constraints, and toxic coolants to deliver more efficient, safer and reliable energy storage. Designed and built with versatility in mind, the AmpliPHI 3.8 Battery features a Battery Management System (BMS) with closed loop communications pre-configured for industry leading inverters that reports SOC and other critical real-time data, optimizing the value of storage and functionality within balance-of-system equipment. Combined with our proven overcurrent protection (OCPD) and accessible 100 Amp DC breaker On/Off switch, installation time is reduced and safety is increased during set-up, making it an ideal solution for battery replacement, expansion of existing systems, or as a new installation for residential and commercial systems, on and off-grid, scalable up to 75 batteries.

FEATURES



Battery Management System (BMS)

Closed-loop communication reports critical real-time data and simplifies installation.



Lithium Ferro Phosphate (LFP) Chemistry

Peace of mind that the elimination of cobalt reduces the risk of thermal runaway, fire propagation, operating temperature constraints, and toxic coolants.



Pair with Leading Inverters

Ready to be integrated industry leading inverters for ease of installation.



Scalable for any energy need

Scale up to 75 batteries to allow for larger storage capacity.

48V Battery Voltage VS. Discharged Capacity

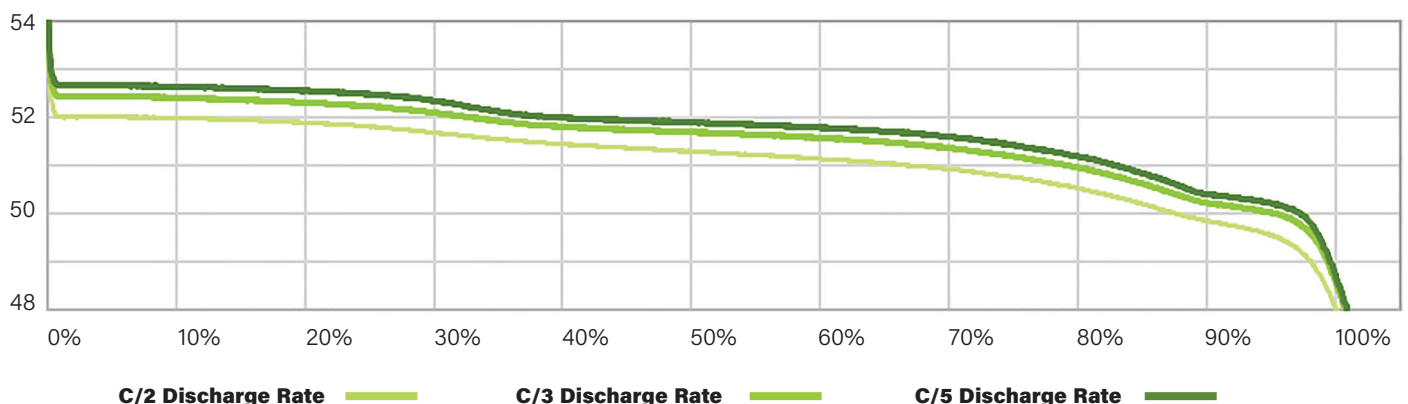

3.8

kWh

AmpliPHI 3.8-M™ Battery



BRIGGS & STRATTON

Specifications	
Model Number	AmpliPHI-3.8-48
DC Voltage - Nominal	51.2 VDC
Amp-Hours	75 Ah
Rated kWh Capacity	3.8 kWh DC @ 100% DOD 3.04 kWh DC @ 80% DOD
Max. Quantity Per System	75 (285kWh)
Max. Discharge Rate (10 minutes)	100 amps DC (51 kW DC)
Max. Continuous Discharge Rate	37.5 Amps DC (1.9 kW DC)
Max. Continuous Charge Rate	37.5 Amps DC (1.9 kW DC)
Certifications	UN 3480, Lithium ion batteries, 9, II UL, CE, UN/DOT and RoHS compliant components - UL 1642, UL 1973, UL 9540A Test Approved

Product Dimensions	
Weight	86 lb (39 kg)
Dimensions (W x H x D)	13.5 x 14 x 8 in. (15.5" H w/terminals) / 0.88 ft ³ (34.3 x 35.6 x 20.3 cm / 0.025 m ³)

Specifications	
Operating Temperature¹	-4° to 140° F (-20° to 60° C)
Storage Temperature	6 months: 14° to 77° F (-10° to 25° C) 3 months: -4° to 113° F (-20° to 45° C)
Self-Discharge Rate	< 1% per month
Cycle Life	10,000+ cycles (@ 80% DOD)
Memory Effect	None
DC Voltage Range¹	48 VDC to 56 VDC
Depth of Discharge¹	up to 100%
Charging Temperature¹	32° to 120° F (0° to 49° C)
Warranty	10 Years
Terminals	3/8 IN (10 mm)
Battery Cables	6 AWG MINIMUM

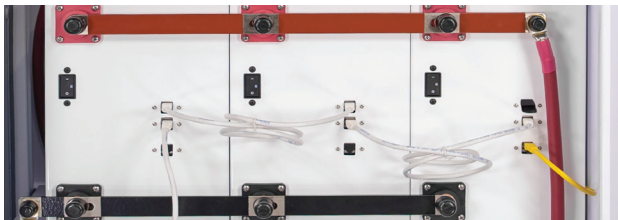

Refer to the Integration Guide section of SimpliPHI's Product Documentation web page for wiring instructions, inverter and/or charge controller specific settings. Must be followed to maintain warranty.

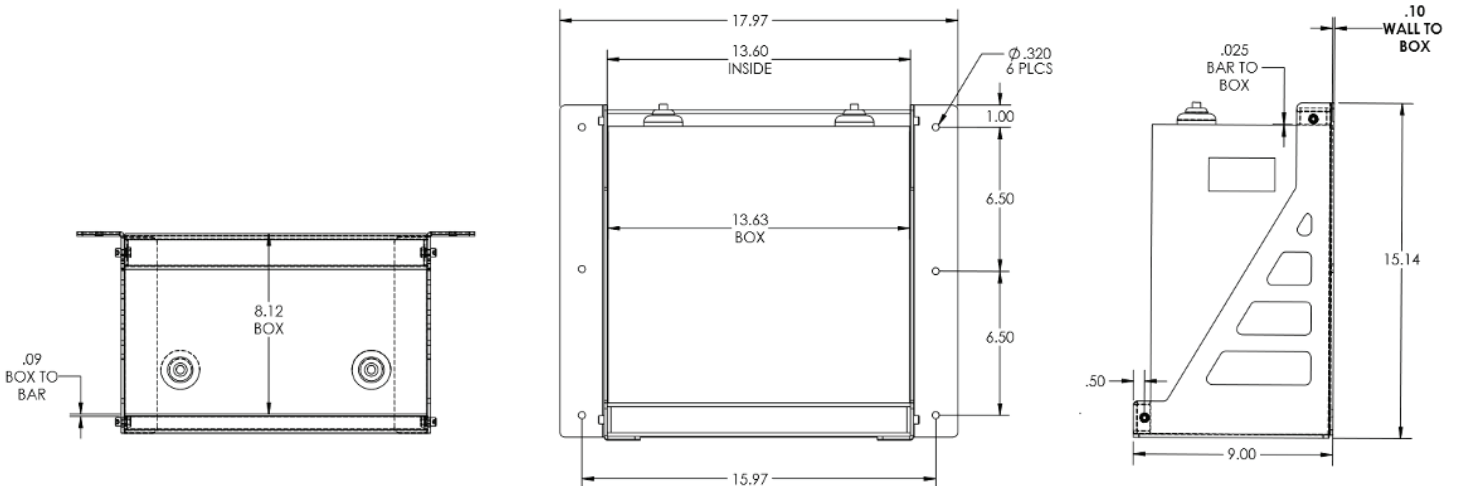
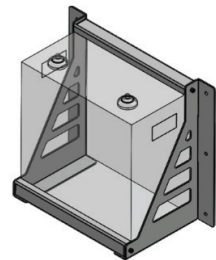

¹ Max operating ranges. Refer to Installation Manual for recommended conditions. All specifications listed are typical/nominal and subject to change without notice. Engineered and Manufactured in California, USA

Briggs & Stratton has a policy of continuous product improvement and reserves the right to modify its specifications at any time and without prior notice. Please visit BRIGGSandSTRATTON.com for the latest information.

BS1396 - 8/22

BRIGGS & STRATTON
POST OFFICE BOX 702
MILWAUKEE, WI 53201 USA