

HUB LiON



LITHIUM
ION BATTERY

HUB-12.8V-150-LFP-31

TECHNICAL DRAWING

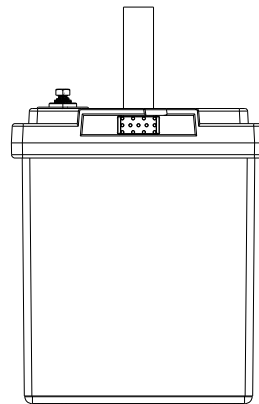
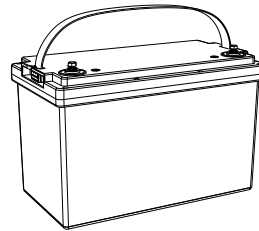
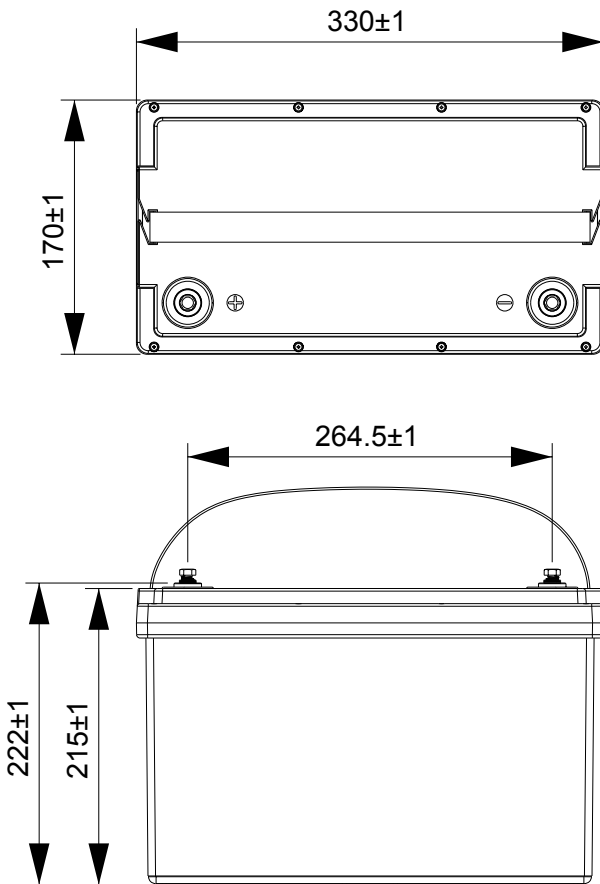

BENEFITS AND ADVANTAGES

Start at the Core

- High Reliability
- Fast and Efficient charge/discharge cycles
- Deep Discharge capability
- Fully Recycle capability
- Light weight
- Environmentally friendly
- UL Approved Cells
- Safety UN38.3 approved
- UN3480, CLASS 9

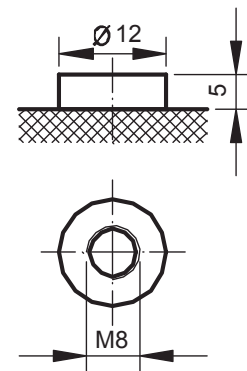

www.hubpower.ca

4238 Lozells Ave #114 Burnaby, BC V5A 0C4

Phone: (604) 420-7737

Email: sales@hubpower.ca

ELECTRICAL SPECIFICATIONS

Nominal Voltage	12.8V
Amp Hour Capacity	150AH
Reserve Capacity @ 25A	360 min
Energy Density	1920Wh
Resistance - Milliohms	< 5
Efficiency - round trip	> 99.5%
Self Discharge per Month	< 3%
**Max 4 - series connections	12-48V
**Max 16 - parallel connections	150-2400AH

**DO NOT configure series and parallel connections simultaneously

TEMPERATURE SPECIFICATIONS

Discharge Temperature	(-20 to 60C)
Charge Temperature	(-20 to 45C)
Storage Temperature	(-5 to 35C)
BMS High Temp Cut Off	95C
BMS Reconnect Temp	75C

CHARGE SPECIFICATIONS

Recommend Charge current	10A - 75A
Max Charge current	150A
Charge current (0 to -10C)	<0.1C
Charge current (-20 to -10C)	<0.05C
Recommended Charge voltage	14.2 - 14.6V
BMS High voltage disconnect	14.8V
BMS High voltage reconnect	14.0V
Balancing voltage	≥3.20V/cell

PERFORMANCE CHARACTERISTICS

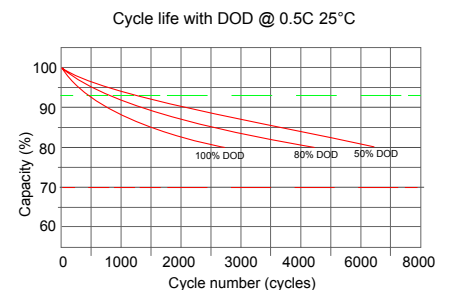
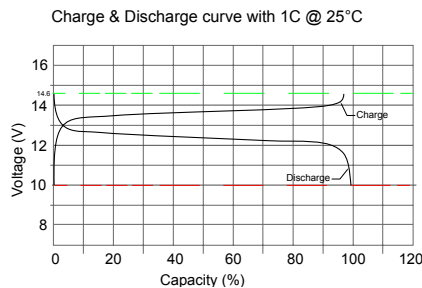
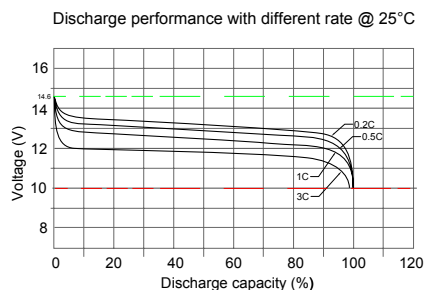

DISCHARGE SPECIFICATIONS

Max Cont Discharge current	150A
Peak Discharge Current 3C	450A
BMS Current Cut Off (10S)	>180A
BMS Current Cut Off (3S)	>225A
BMS Current Cut Off	Load Short circuit
BMS Low Voltage Cut Off	8.8V
BMS Low Reconnect Voltage	12V

MECHANICAL SPECIFICATIONS

Dimensions	12.99 x 6.69 x 8.74in
L x W x H	330x 170 x 222 mm
Weight	37.94lbs (17.72KG)
Terminal Type	M8
Terminal Torque	90 in lbs (10NM)
Case Material	ABS
Case IP Rating	IP56
Cell Type - Chemistry	LiFePO4
Cell Type	Prismatic

HEATING CIRCUIT

Operating Range	(-20 to 5C)
Heating Circuit Engages at	≤ 0C
Heating Circuit Disengages at	+5C

SAFETY TESTED

Safety Ratings	CB / CE UN38.3 @ cell UL1973 @ cell
Shipping Classification	UN3480, CLASS 9